

FINANCIAL FACT BOOK 2001

OMRON

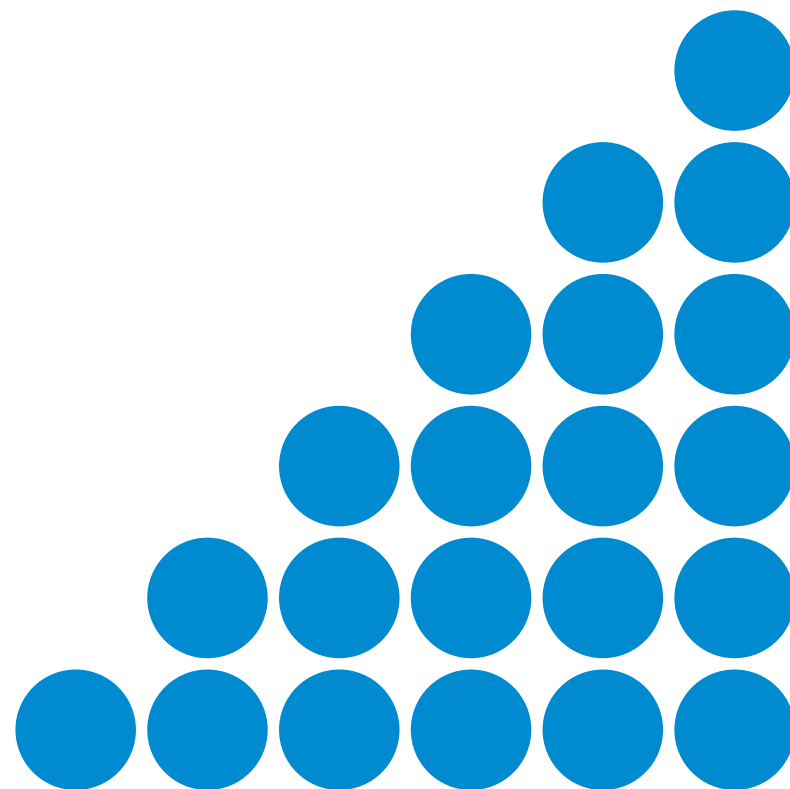
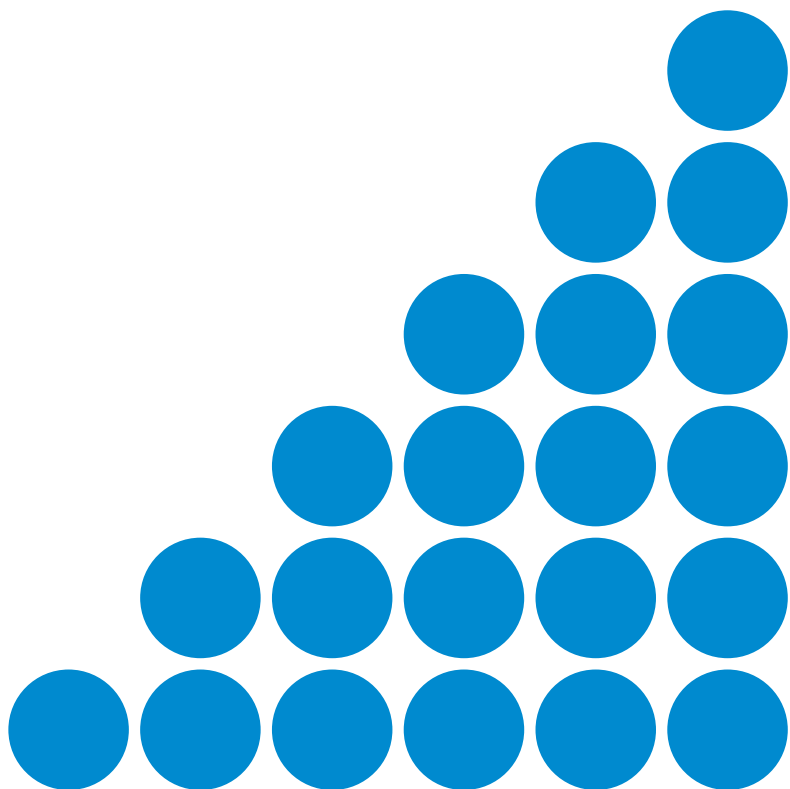

CONTENTS

目次

Sales Data		売上
Net Sales	1	売上高
Sales Composition	2	部門別売上高構成
Sales by Region	3	地域別売上高構成
Profit Data		利益
Cost Composition & Operating Income/Net Sales	4	費用構成・売上高営業利益率
Gross Profit Margin		売上総利益率
SG & A Expenses/Net Sales, R & D Expenses/Net Sales	5	売上高販売管理費比率・売上高研究開発費比率
Income Before Tax/Net Sales, Net Income/Net Sales		売上高税引前純利益率・売上高当期純利益率
Net Sales & Net Income per Employee	6	従業員1人当り売上高・当期純利益
Interest Expenses & Interest Coverage	7	支払利息・インタレスト カバレッジ
Earnings per Share & Price-Earnings Ratio		1株当り利益・株価収益率
Financial Statement Related Ratio		財務諸表に関する指標
Current Ratio & Working Capital	8	流動比率・運転資本
Total Assets Turnover		総資産回転率
Inventory Turnover	9	たな卸資産資産回転率
Tangible Fixed Assets Turnover		有形固定資産回転率
Return on Tangible Fixed Assets	10	有形固定資産当期純利益率
Capital Expenditures & Cash Flows		設備投資額・キャッシュフロー
Return on Stockholders' Equity	11	株主資本当期純利益率
Return on Assets		総資産税引前純利益率
Stockholders' Equity/Total Assets	12	株主資本比率
Aggregate market value & Price Book-value Ratio		時価総額・P.B.R.
Cash Flows per Share	13	1株当りキャッシュフロー
Financial Statement		財務諸表
Consolidated Statements of Income	14	連結損益計算書
Consolidated Balance Sheets	15.16	連結貸借対照表
Consolidated Statements of Cash Flows	17	連結資金収支計算書
Basic Information		概要
Main Products	18	主要製品
Common Stock Price Range	19	株価推移
Corporate Organization Chart	20	組織図
Corporate Data	21	会社概要

Notes:

- Figures have been calculated on a consolidated basis for the years ended March 31.
- Not all data have been audited. Refer to respective annual reports for audited figures.
- Data might be revised according to alterations to accounting standards.

注:

- 記載されている数値は連結ベース。会計年度は4月1日～3月31日です。
- 監査されていないデータもあります。監査された数値に関しては、アニュアル・レポートを参照下さい。
- 会計制度の変更等により過去に遡って数値の修正を行うことがあります。

Net Sales

売上高

Net Sales
売上高

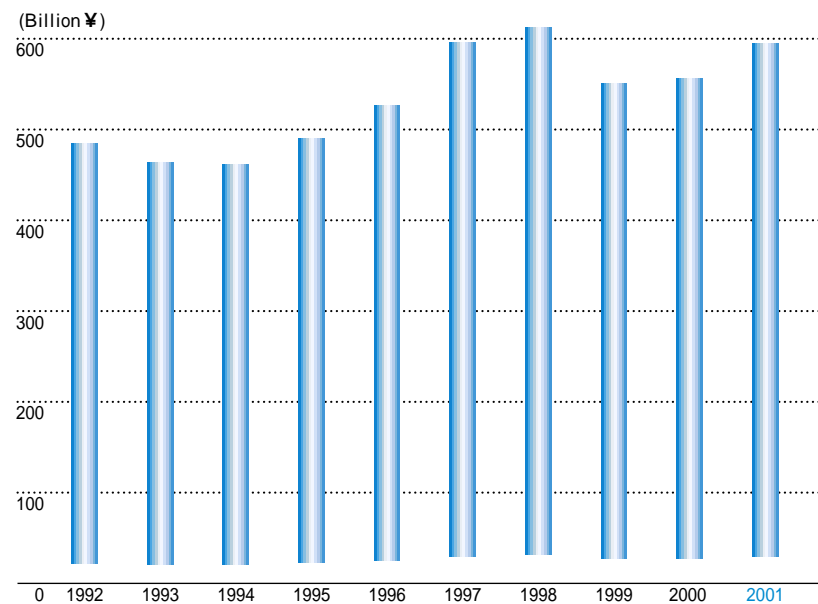

Net Sales 売上高

Fiscal Year ~年3月期		1992	1993	1994	1995	1996	1997	1998	1999	2000	2001
Net Sales 売上高	(Million ¥)	483,247	462,702	460,869	489,700	525,289	594,261	611,795	555,280	555,358	594,259
Annual Change 前年比	(%)	+ 4.1	- 4.3	- 0.4	+ 6.3	+ 7.3	+13.1	+ 3.0	- 9.2	± 0.0	+ 7.0

Sales Composition

部門別売上高構成

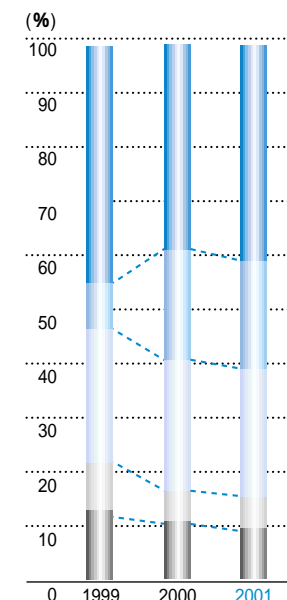
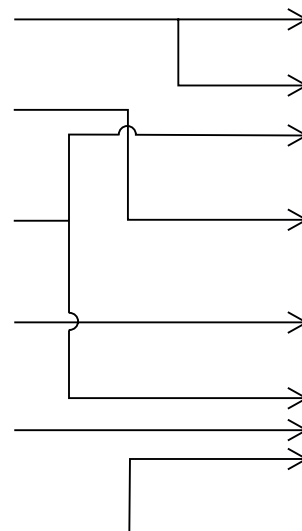
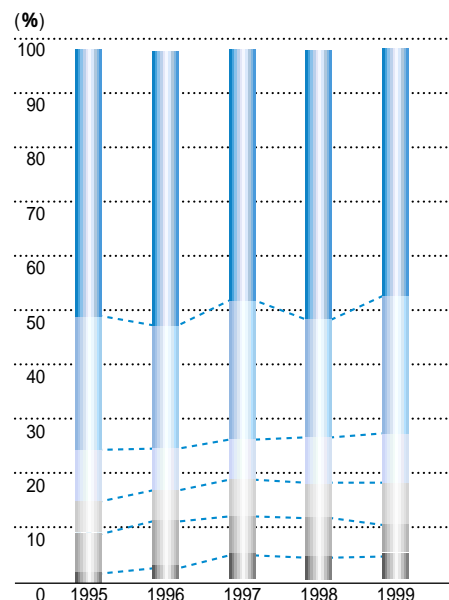

Sales Composition 部門別売上高構成

Fiscal Year ~年3月期		1995	1996	1997	1998	1999		1999	2000	2001	
Control Components and Systems 制御システム機器	(Million ¥) (%)	248,023 (50.6)	275,149 (52.3)	291,227 (49.0)	313,642 (51.3)	267,503 (48.2)	Industrial Automation Company インダストリアルオートメーションビジネスカンパニー	(Million ¥) (%)	245,785 (44.2)	215,087 (38.7)	239,225 (40.3)
Social Business 電子決済・公共情報システム	(Million ¥) (%)	127,382 (26.0)	125,623 (23.9)	145,172 (24.5)	138,203 (22.6)	135,872 (24.5)	Electronic Components Company エレクトロニクスコンポーネツビジネスカンパニー	(Million ¥) (%)	56,673 (10.2)	109,661 (19.8)	117,910 (19.8)
Specialty Products 専用機器	(Million ¥) (%)	42,465 (8.7)	38,687 (7.4)	46,533 (7.8)	47,263 (7.7)	51,338 (9.2)	Social Systems Business Company ソーシャルシステムズビジネスカンパニー	(Million ¥) (%)	135,872 (24.5)	128,534 (23.1)	141,928 (23.9)
Healthcare 健康機器	(Million ¥) (%)	28,790 (5.9)	31,618 (6.0)	36,388 (6.1)	40,793 (6.7)	43,729 (7.9)	Healthcare Company ヘルスケアビジネスカンパニー	(Million ¥) (%)	43,729 (7.9)	42,640 (7.7)	39,327 (6.6)
Open Systems オープンシステム	(Million ¥) (%)	34,672 (7.1)	38,621 (7.4)	50,187 (8.4)	50,131 (8.2)	31,908 (5.7)	Others その他	(Million ¥) (%)	73,221 (13.2)	59,436 (10.7)	55,869 (9.4)
Others その他	(Million ¥) (%)	8,368 (1.7)	15,591 (3.0)	24,704 (4.2)	21,763 (3.5)	24,930 (4.5)	Total	(Million ¥) (%)	555,280 (100.0)	555,358 (100.0)	594,259 (100.0)
Total	(Million ¥) (%)	489,700 (100.0)	525,289 (100.0)	594,261 (100.0)	611,795 (100.0)	555,280 (100.0)					

: OMRON Introduced the internal company system in April 1999.

: 99/4から社内カンパニー制を導入しています。

Sales by Region

地域別売上高構成

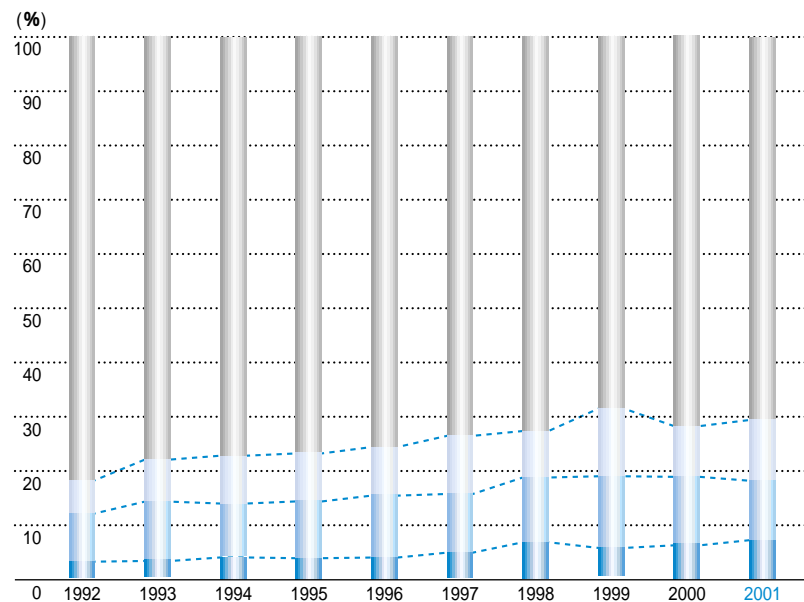

Sales by Region 地域別売上高構成

Fiscal Year ~年3月期		1992	1993	1994	1995	1996	1997	1998	1999	2000	2001
Japan 日本	(Million ¥) (%)	396,515 (82.0)	367,703 (79.4)	364,696 (79.1)	383,286 (78.3)	402,573 (76.6)	442,269 (74.4)	440,614 (72.0)	387,734 (69.8)	397,236 (71.5)	423,825 (71.3)
North America 北米	(Million ¥) (%)	28,119 (5.8)	31,349 (6.8)	33,094 (7.2)	35,337 (7.2)	38,284 (7.3)	52,503 (8.8)	61,169 (10.0)	58,233 (10.5)	59,474 (10.7)	64,373 (10.8)
Europe ヨーロッパ	(Million ¥) (%)	43,331 (9.0)	46,218 (10.0)	44,785 (9.7)	51,510 (10.5)	58,802 (11.2)	67,134 (11.3)	73,901 (12.1)	77,218 (13.9)	61,297 (11.0)	61,038 (10.3)
Asia-Pacific アジア・パシフィック	(Million ¥) (%)	15,282 (3.2)	17,432 (3.8)	18,294 (4.0)	19,567 (4.0)	25,630 (4.9)	32,355 (5.5)	36,111 (5.9)	32,095 (5.8)	37,351 (6.7)	45,023 (7.6)
Total	(Million ¥) (%)	483,247 (100.0)	462,702 (100.0)	460,869 (100.0)	489,700 (100.0)	525,289 (100.0)	594,261 (100.0)	611,795 (100.0)	555,280 (100.0)	555,358 (100.0)	594,259 (100.0)

: Export sales from Japan directly to overseas customers are included in the sales figures for Japan.
Overseas sales ratio amounts to 30.7% as of March, 2001.

: 海外売上高のうち、日本からの直接輸出は上の「日本」の中に含まれます。01年3月期の海外売上高比率は30.7%です。

Cost Composition & Operating Income / Net Sales

費用構成・売上高営業利益率

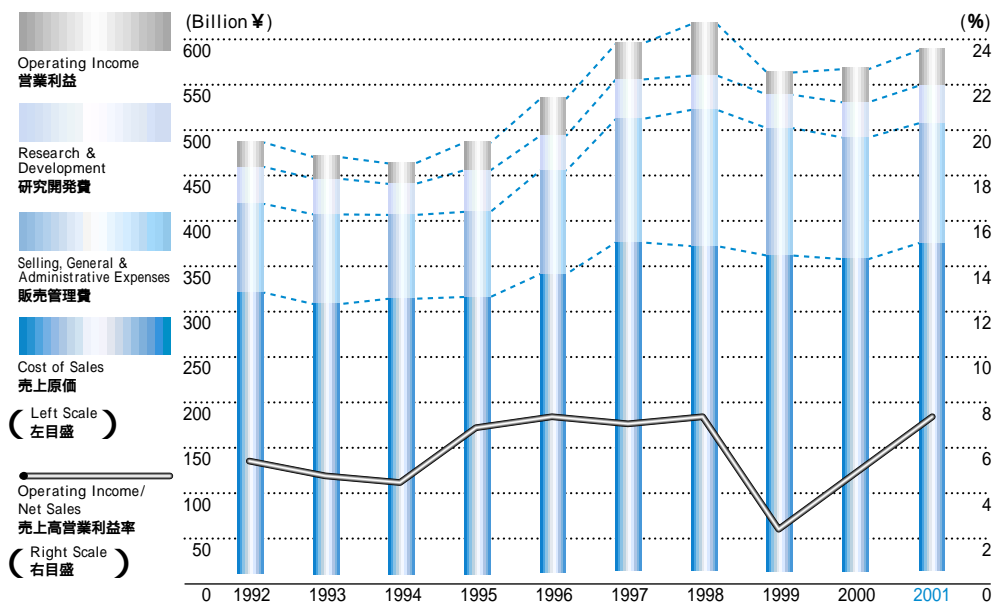

Gross Profit Margin

売上総利益率

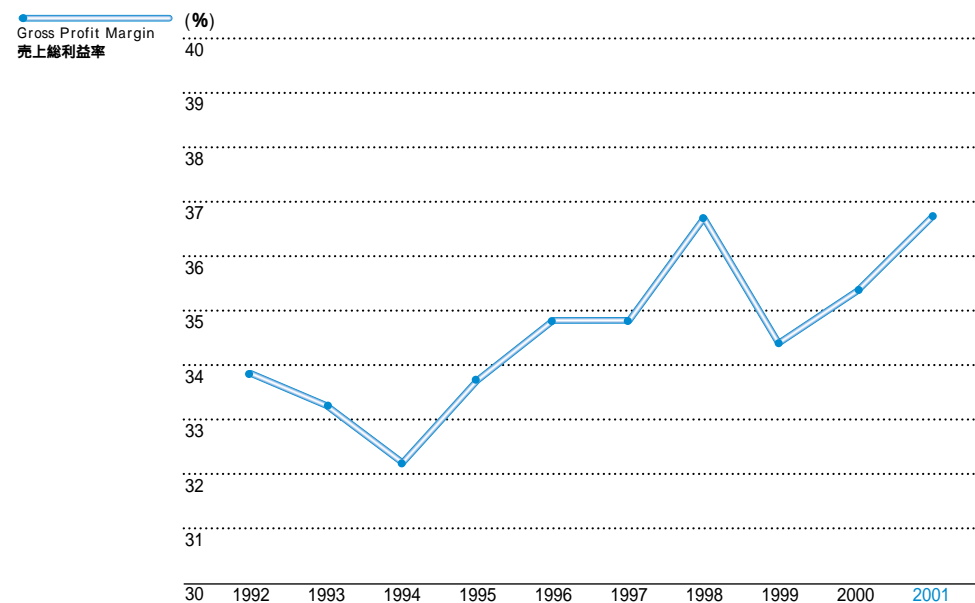

Cost Composition & Operating Income / Net Sales 費用構成・売上高営業利益率

Fiscal Year ~年3月期		1992	1993	1994	1995	1996	1997	1998	1999	2000	2001
Net Sales 売上高	(Million ¥)	483,247	462,702	460,869	489,700	525,289	594,261	611,795	555,280	555,358	594,259
Cost of Sales 売上原価	(Million ¥)	319,589	308,579	312,248	324,666	342,500	388,005	387,445	364,314	358,911	376,194
SG & A Expenses 販売管理費	(Million ¥)	103,463	102,430	100,193	100,333	109,117	130,163	138,404	136,734	133,662	131,203
Research & Development 研究開発費	(Million ¥)	33,587	31,004	28,698	31,223	34,433	35,188	39,914	42,383	36,605	42,513
Operating Income 営業利益	(Million ¥)	26,608	20,689	19,730	33,478	39,239	40,905	46,032	11,849	26,180	44,349
Operating Income / Net Sales 売上高営業利益率	(%)	5.5	4.5	4.3	6.8	7.5	6.9	7.5	2.1	4.7	7.5

Gross Profit Margin 売上総利益率

Fiscal Year ~年3月期		1992	1993	1994	1995	1996	1997	1998	1999	2000	2001
Gross Profit 売上総利益	(Million ¥)	163,658	154,123	148,621	165,034	182,789	206,256	224,350	190,966	196,447	218,065
Net Sales 売上高	(Million ¥)	483,247	462,702	460,869	489,700	525,289	594,261	611,795	555,280	555,358	594,259
Gross Profit Margin 売上総利益率	(%)	33.9	33.3	32.2	33.7	34.8	34.7	36.7	34.4	35.4	36.7

Note : Gross Profit Margin = Gross Profit / Net Sales

注：売上総利益率 = 売上総利益 / 売上高

SG & A Expenses / Net Sales, SG & D Expenses / Net Sales 売上高販売管理費比率・売上高研究開発費比率

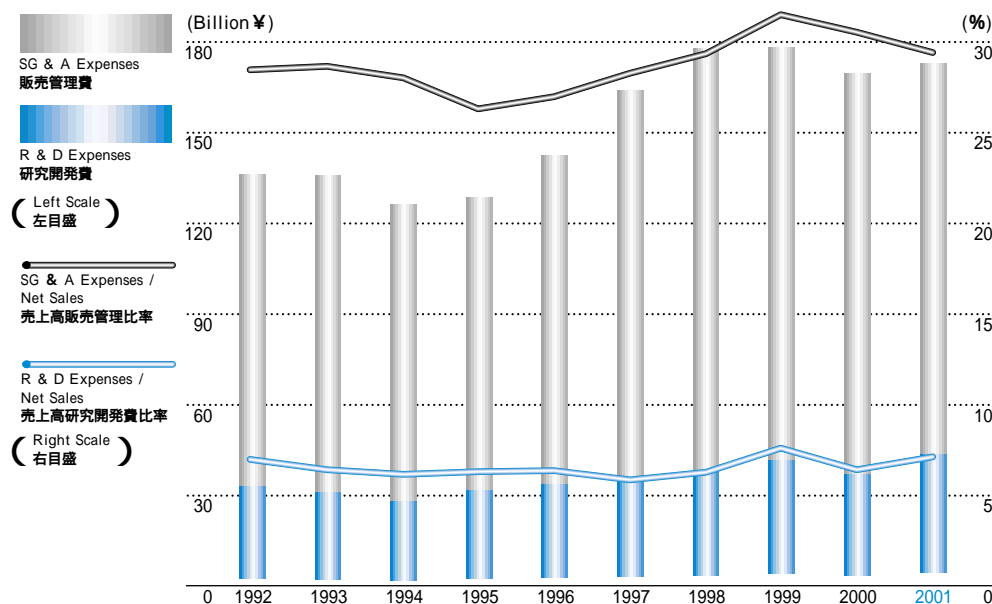

Income Before Tax / Net Sales, Net Income / Net Sales 売上高税引前純利益率・売上高当期純利益率

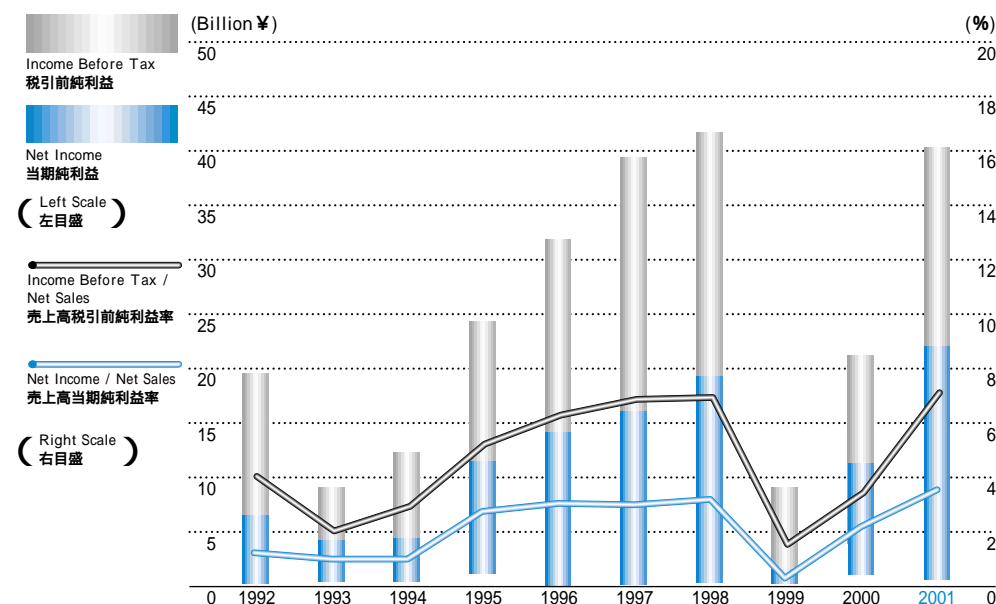

SG & A Expenses / Net Sales, SG & D Expenses / Net Sales 売上高販売管理費比率・売上高研究開発費比率

Fiscal Year ~年3月期		1992	1993	1994	1995	1996	1997	1998	1999	2000	2001
SG & A Expenses (include R & D) 販売管理費 (研究開発費含む)	(Million ¥)	137,050	133,434	128,891	131,556	143,550	165,351	178,318	179,117	170,267	173,716
R & D Expenses 研究開発費	(Million ¥)	33,587	31,004	28,698	31,223	34,433	35,188	39,914	42,383	36,605	42,513
Net Sales 売上高	(Million ¥)	483,247	462,702	460,869	489,700	525,289	594,261	611,795	555,280	555,358	594,259
SG & A Expenses / Net Sales 売上高販売管理費比率	(%)	28.4	28.8	28.0	26.9	27.3	27.8	29.1	32.3	30.7	29.2
R & D Expenses / Net Sales 売上高研究開発費比率	(%)	7.0	6.7	6.2	6.4	6.6	5.9	6.5	7.6	6.6	7.2

Income Before Tax / Net Sales, Net Income / Net Sales 売上高税引前純利益率・売上高当期純利益率

Fiscal Year ~年3月期		1992	1993	1994	1995	1996	1997	1998	1999	2000	2001
Income Before Tax 税引前純利益	(Million ¥)	19,803	9,375	13,062	24,948	32,252	39,248	42,243	8,249	21,036	40,037
Net Income 当期純利益	(Million ¥)	6,172	4,573	4,690	12,152	14,587	15,739	18,704	2,174	11,561	22,297
Net Sales 売上高	(Million ¥)	483,247	462,702	460,869	489,700	525,289	594,261	611,795	555,280	555,358	594,259
Income Before Tax / Net Sales 売上高税引前純利益率	(%)	4.1	2.0	2.8	5.1	6.1	6.6	6.9	1.5	3.8	6.7
Net Income / Net Sales 売上高当期純利益率	(%)	1.3	1.0	1.0	2.5	2.8	2.6	3.1	0.4	2.1	3.8

Net Sales & Net Income per Employee

従業員1人当り売上高・当期純利益

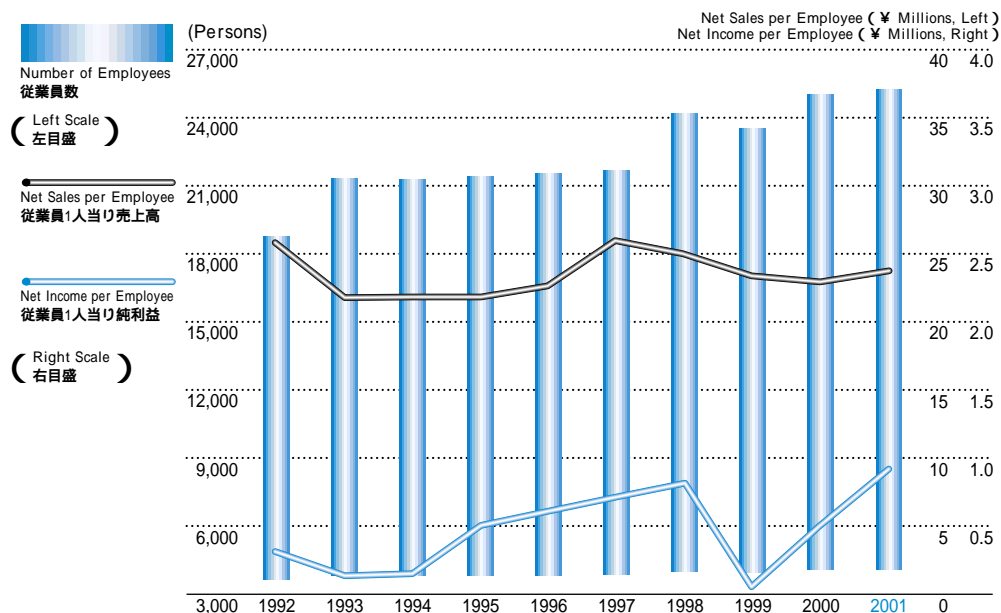

Interest Expenses & Interest Coverage

支払利息・インタレスト カバレッジ

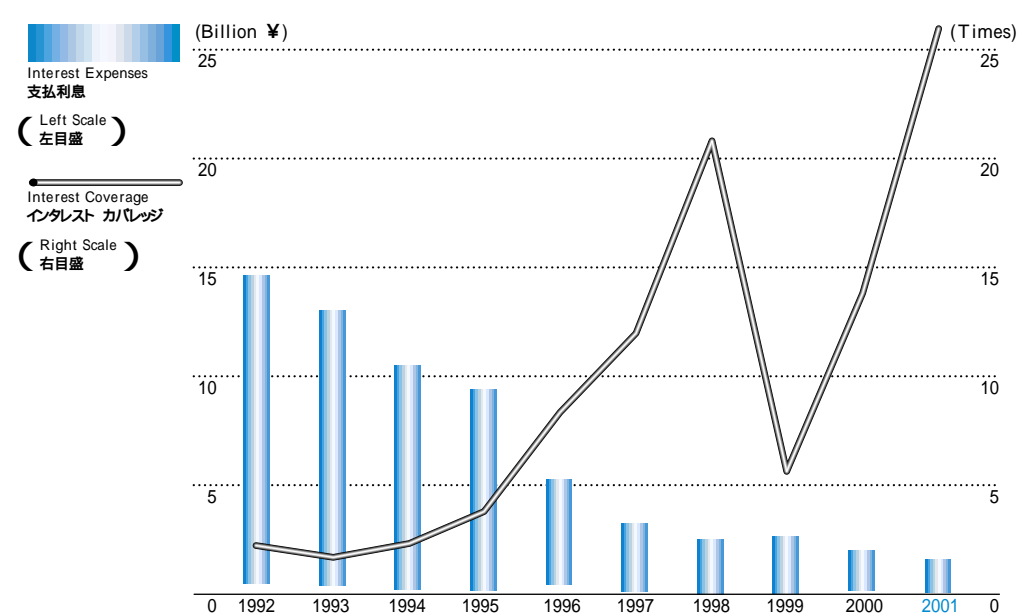

Net Sales & Net Income per Employee 従業員1人当り売上高・当期純利益

Fiscal Year ~年3月期		1992	1993	1994	1995	1996	1997	1998	1999	2000	2001
Number of Employees 従業員数	(Persons)	18,681	21,494	21,346	22,428	22,748	23,244	24,048	23,742	24,915	25,067
Net Sales 売上高	(Million ¥)	483,247	462,702	460,869	489,700	525,289	594,261	611,795	555,280	555,358	594,259
Net Sales per Employee 従業員1人当り売上高	(Million ¥)	26	22	22	22	23	26	25	23	22	24
Net Income 当期純利益	(Million ¥)	6,172	4,573	4,690	12,152	14,587	15,739	18,704	2,174	11,561	22,297
Net Income per Employee 従業員1人当り当期純利益	(Million ¥)	0.3	0.2	0.2	0.5	0.6	0.7	0.8	0.1	0.5	0.9

Note : Number of Employees at the end of each fiscal year. 注 : 従業員数は各年度末数値

Interest Expenses & Interest Coverage 支払利息・インタレスト カバレッジ

Fiscal Year ~年3月期		1992	1993	1994	1995	1996	1997	1998	1999	2000	2001
Operating Income 営業利益	(Million ¥)	26,608	20,689	19,730	33,478	39,239	40,905	46,032	11,849	26,180	44,349
Interest Income 受取利息	(Million ¥)	10,196	7,853	4,214	3,592	3,031	1,967	1,730	1,656	1,147	1,620
Dividends Received 受取配当金	(Million ¥)	943	920	1,212	932	706	786	600	496	441	477
Interest Expenses 支払利息	(Million ¥)	14,191	13,454	10,642	8,694	5,075	3,557	2,412	2,518	1,897	1,731
Interest Coverage インタレスト カバレッジ	(Times)	2.66	2.19	2.36	4.37	8.47	12.27	20.05	5.56	14.64	26.83

Note : Interest Coverage =(Operating Income+Interest Income & Dividends Received)/(Interest Expenses) 注 : インタレスト カバレッジ=(営業利益+受取利息及び受取配当金)/(支払利息)

Earnings per Share & Price-Earnings Ratio

1株当り利益・株価収益率

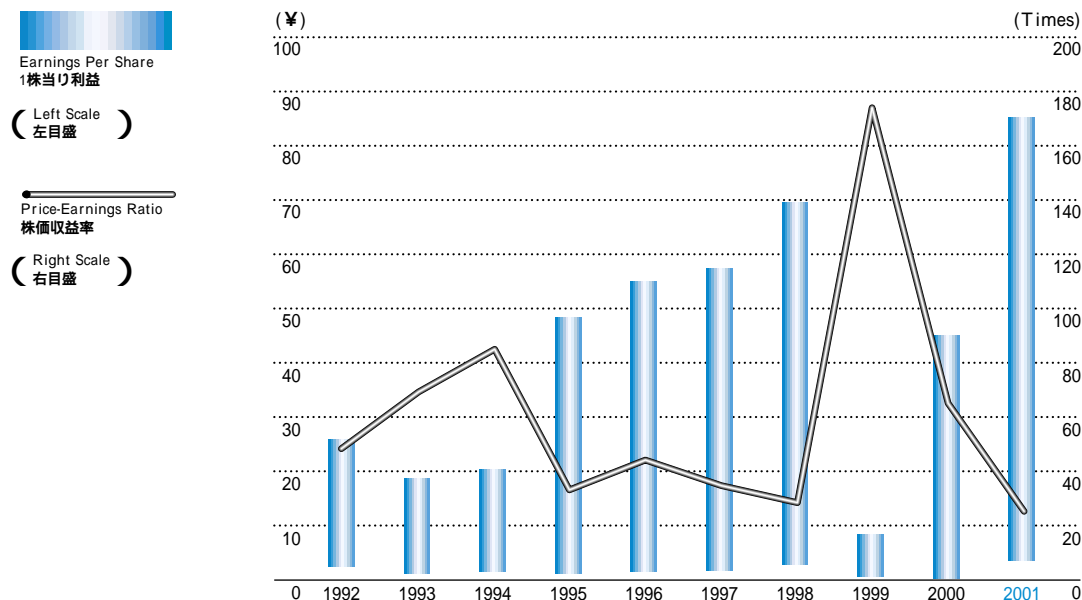

Earnings per Share & Price-Earnings Ratio 1株当り利益・株価収益率

Fiscal Year ~年3月期		1992	1993	1994	1995	1996	1997	1998	1999	2000	2001
Earnings per Share 1株当り利益	(¥)	26.1	19.6	20.1	49.4	54.5	58.8	69.8	8.3	44.53	85.33
Price-Earnings Ratio 株価収益率	(Times)	51.6	69.7	83.2	35.4	42.2	36.6	28.3	175.0	64.9	24.8

Notes : Earnings per Share are based on the weighted average number of Shares of Common Stock and Common Stock equivalents with a dilutive effect outstanding during each year, adjusted for the free share distributions.

PER = Fiscal-year-end Adjusted Stock Price / (Net Income / Number of Shares)

注：1株当り利益は、株式分割を考慮、修正し、各年度末の加重平均株式数に基づいて計算されています。

株価収益率 = 修正株価 (各年度末) / (当期純利益 / 株数)

Current Ratio & Working Capital

流動比率・運転資本

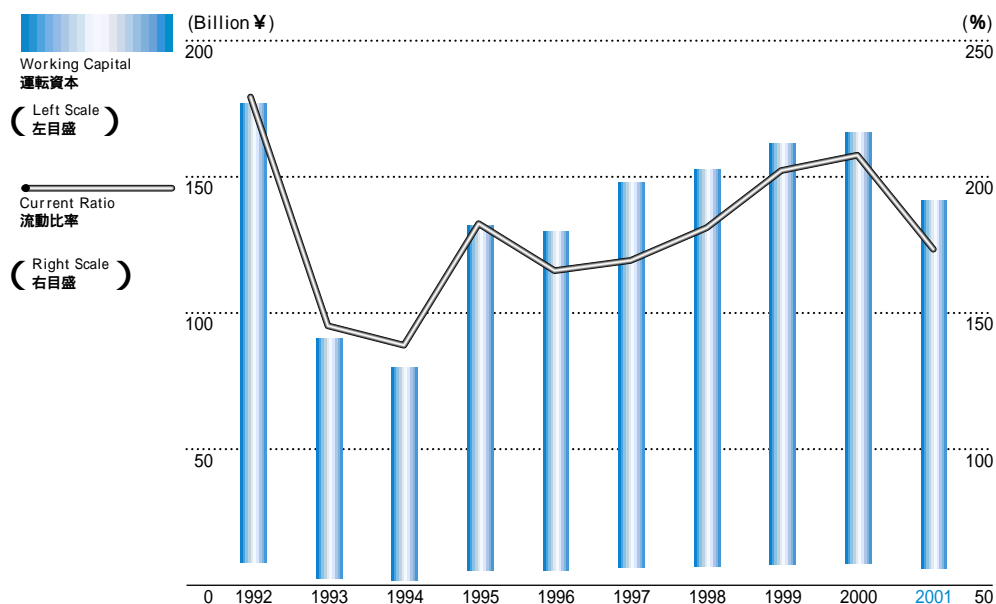

Total Assets Turnover

総資産回転率

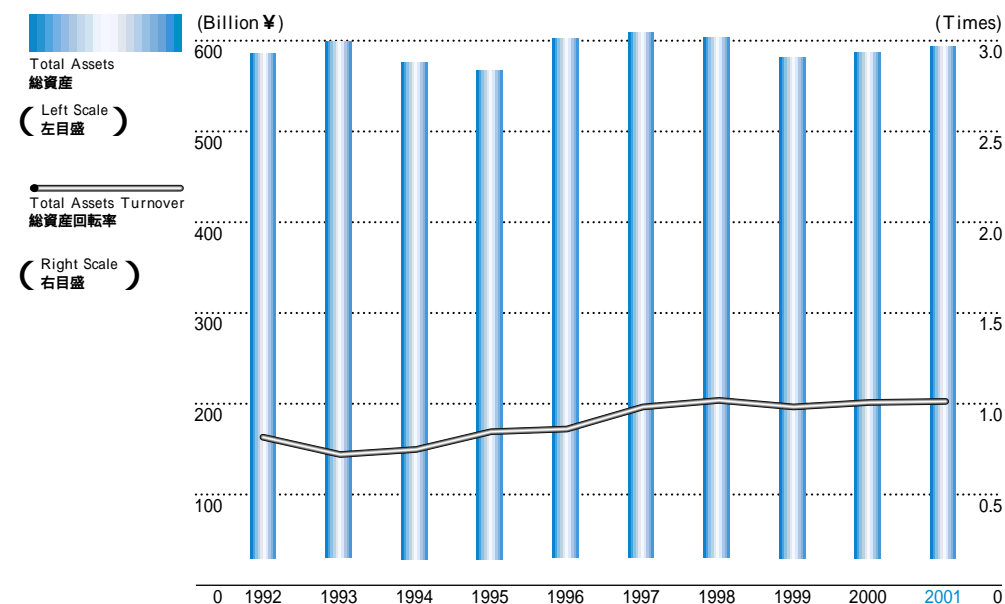

Current Ratio & Working Capital 流動比率・運転資本

Fiscal Year ~年3月期		1992	1993	1994	1995	1996	1997	1998	1999	2000	2001
Current Assets 流動資産	(Million ¥)	312,769	288,345	282,467	294,775	325,738	340,421	328,747	322,263	317,273	328,879
Current Liabilities 流動負債	(Million ¥)	139,297	194,990	200,033	156,289	188,334	191,632	176,948	157,653	147,476	183,390
Current Ratio 流動比率	(%)	225	148	141	189	173	178	186	204	215	179
Working Capital 運転資本	(Million ¥)	173,472	93,355	82,434	138,486	137,404	148,789	152,799	164,610	169,797	145,489

Note : Current Ratio = Current Assets / Current Liabilities
Working Capital = Current Assets - Current Liabilities

注：流動比率 = 流動資産 / 流動負債
運転資本 = 流動資産 - 流動負債

Total Assets Turnover 総資産回転率

Fiscal Year ~年3月期		1992	1993	1994	1995	1996	1997	1998	1999	2000	2001
Net Sales 売上高	(Million ¥)	483,247	462,702	460,869	489,700	525,289	594,261	611,795	555,280	555,358	594,259
Total Assets 総資産	(Million ¥)	588,802	599,831	570,991	569,794	600,172	611,930	602,030	579,489	580,038	593,144
Total Assets Turnover 総資産回転率	(Times)	0.82	0.77	0.81	0.86	0.88	0.97	1.02	0.95	0.96	1.00

Notes : Total Assets are based on the average of the beginning and end of each fiscal year.
Total Assets Turnover = Net Sales / Total Assets

注：総資産は期中平均
総資産回転率 = 売上高 / 総資産

Inventory Turnover

たな卸資産回転率

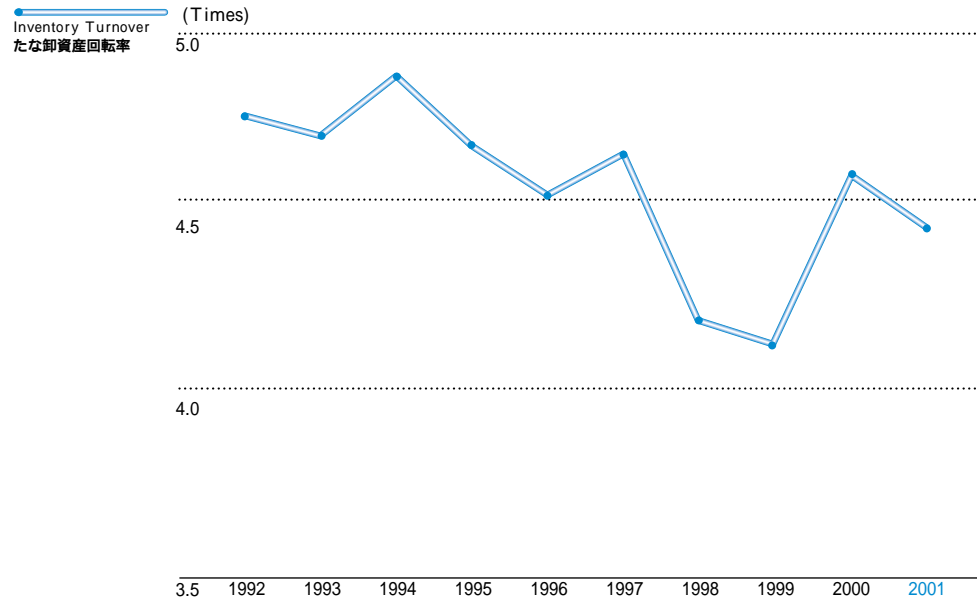

Tangible Fixed Assets Turnover

有形固定資産回転率

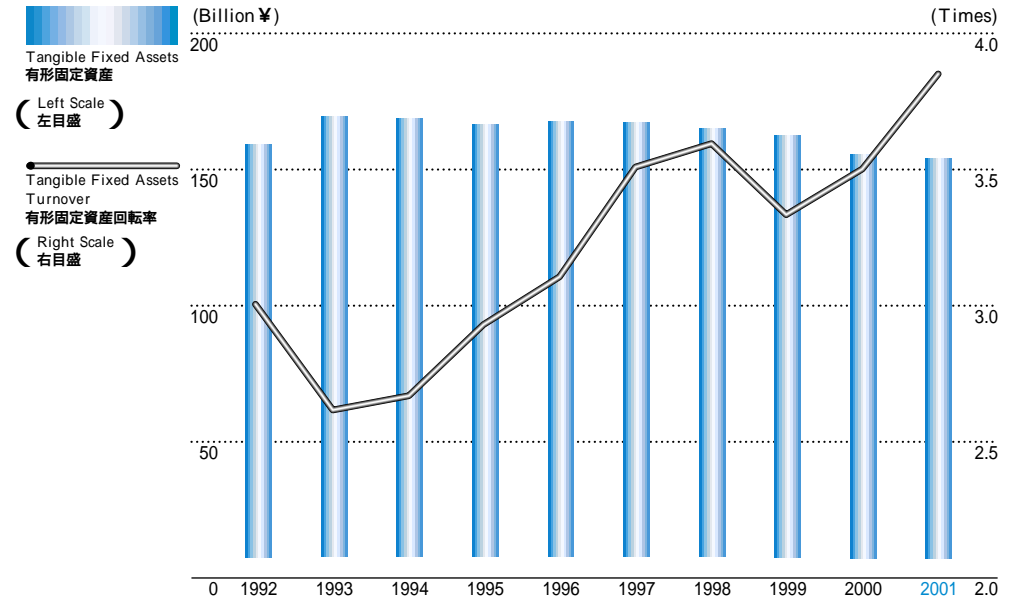

Inventory Turnover たな卸資産回転率

Fiscal Year ~年3月期	1992	1993	1994	1995	1996	1997	1998	1999	2000	2001
Cost of Sales 売上原価 (Million ¥)	319,589	308,579	312,248	324,666	342,500	388,005	387,445	364,314	358,911	376,194
Inventory たな卸資産 (Million ¥)	67,274	65,642	64,275	69,272	75,892	83,237	90,474	87,258	78,671	84,700
Inventory Turnover たな卸資産回転率 (Times)	4.75	4.70	4.86	4.69	4.51	4.66	4.28	4.18	4.56	4.44

Notes : Inventory is based on the average of the beginning and end of each fiscal year.
Inventory Turnover = Cost of Sales / Inventory

注 : たな卸資産は期中平均
たな卸資産回転率 = 売上原価 / たな卸資産

Tangible Fixed Assets Turnover 有形固定資産回転率

Fiscal Year ~年3月期	1992	1993	1994	1995	1996	1997	1998	1999	2000	2001
Net Sales 売上高 (Million ¥)	483,247	462,702	460,869	489,700	525,289	594,261	611,795	555,280	555,358	594,259
Tangible Fixed Assets 有形固定資産 (Million ¥)	162,326	175,308	171,622	167,830	170,453	171,553	170,446	166,689	159,465	157,577
Tangible Fixed Assets Turnover 有形固定資産回転率 (Times)	3.0	2.6	2.7	2.9	3.1	3.5	3.6	3.3	3.5	3.8

Notes : Tangible Fixed Assets are based on the average of the beginning and end of each fiscal year.
Tangible Fixed Assets Turnover = Net Sales / Tangible Fixed Assets

注 : 有形固定資産は、期中平均
有形固定資産回転率 = 売上高 / 有形固定資産

Return on Tangible Fixed Assets

有形固定資産当期純利益率

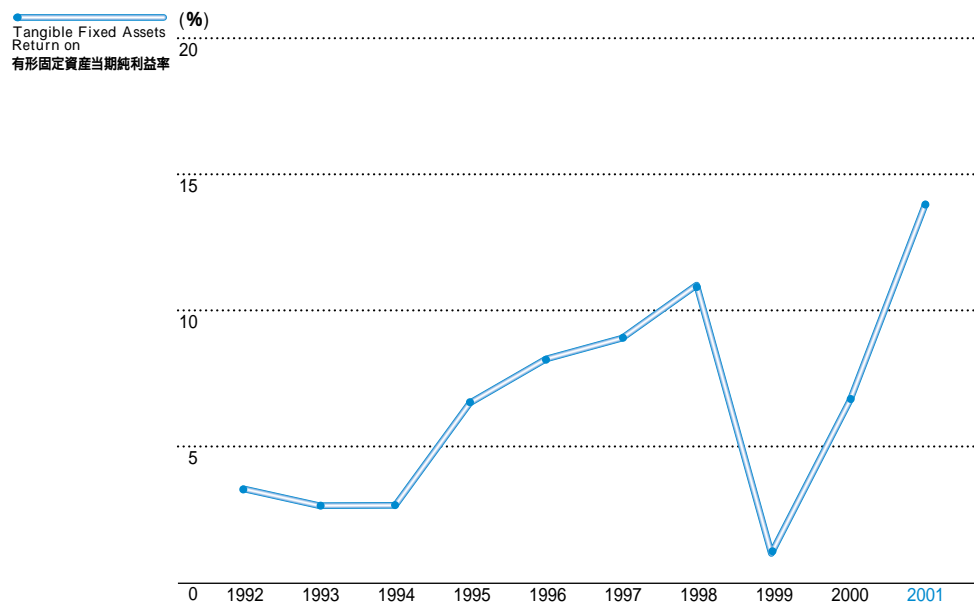

Capital Expenditures & Cash Flows

設備投資額・キャッシュフロー

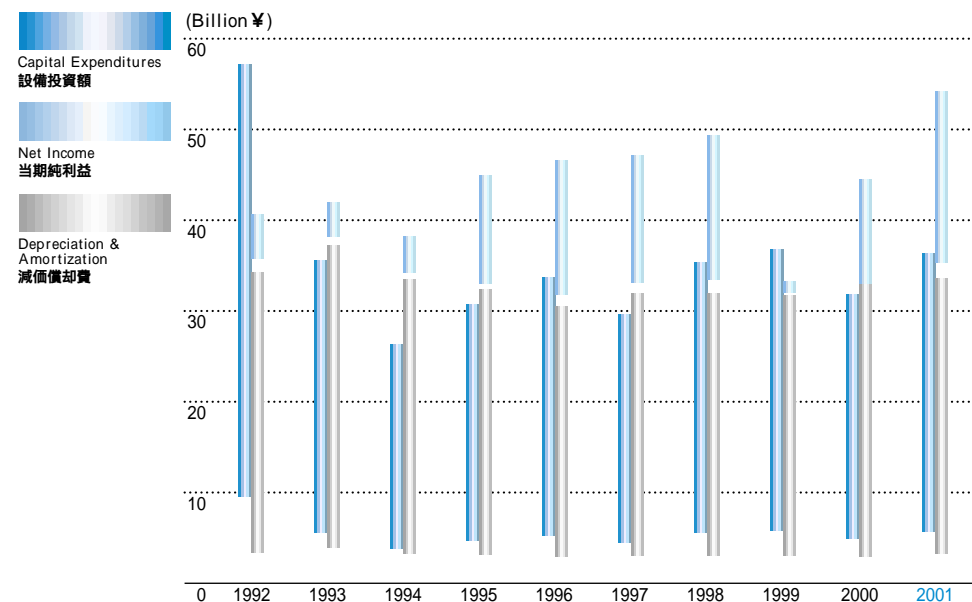

Return on Tangible Fixed Assets 有形固定資産当期純利益率

Fiscal Year ~年3月期		1992	1993	1994	1995	1996	1997	1998	1999	2000	2001
Net Income 当期純利益	(Million ¥)	6,172	4,573	4,690	12,152	14,587	15,739	18,704	2,174	11,561	22,297
Tangible Fixed Assets 有形固定資産	(Million ¥)	162,326	175,308	171,622	167,830	170,453	171,553	170,446	166,689	159,465	157,577
Return on Tangible Fixed Assets 有形固定資産当期純利益率	(%)	3.8	2.6	2.7	7.2	8.6	9.2	11.0	1.3	7.2	14.1

Notes : Tangible Fixed Assets are based on the average of the beginning and end of each fiscal year.
Return on Tangible Fixed Assets = Net Income / Tangible Fixed Assets

注 : 有形固定資産は期中平均
有形固定資産当期純利益率 = 当期純利益 / 有形固定資産

Capital Expenditures & Cash Flows 設備投資額・キャッシュフロー

Fiscal Year ~年3月期		1992	1993	1994	1995	1996	1997	1998	1999	2000	2001
Capital Expenditures 設備投資額	(Million ¥)	57,575	34,584	26,875	30,954	34,079	29,956	35,896	36,696	31,146	37,583
Net Income 当期純利益	(Million ¥)	6,172	4,573	4,690	12,152	14,587	15,739	18,704	2,174	11,561	22,297
Depreciation & Amortization 減価償却費	(Million ¥)	34,736	37,607	33,502	31,438	30,196	31,234	31,129	31,396	31,445	32,217
Cash Flows キャッシュフロー	(Million ¥)	40,908	42,180	38,192	43,590	44,783	46,973	49,833	33,570	43,006	54,514

Note : Cash Flows = Net Income + (Depreciation & Amortization)

注 : キャッシュフロー = 当期純利益 + 減価償却費

Return on Stockholders' Equity

株主資本当期純利益率

Return on Stockholders' Equity (%)
株主資本当期純利益率

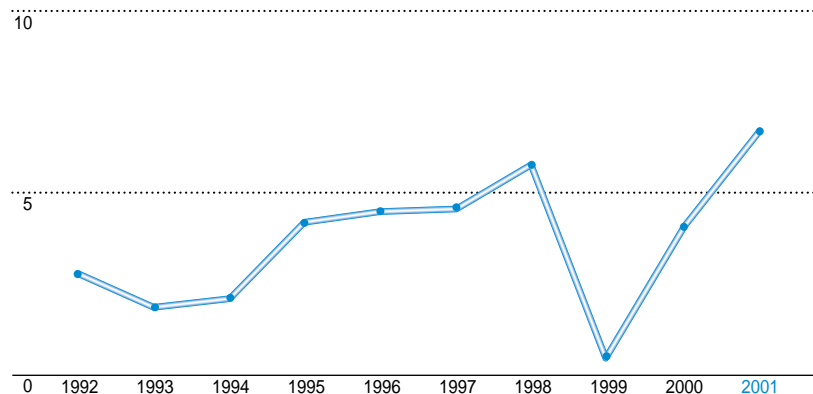

Return on Assets

総資産税引前純利益率

Return on Assets (%)
総資産税引前純利益率

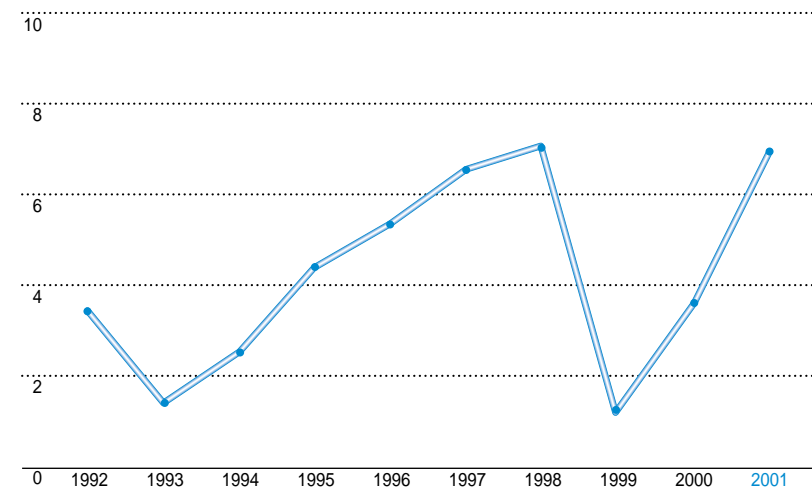

Return on Stockholders' Equity 株主資本当期純利益率

Fiscal Year ~年3月期	1992	1993	1994	1995	1996	1997	1998	1999	2000	2001
Net Income 当期純利益 (Million ¥)	6,172	4,573	4,690	12,152	14,587	15,739	18,704	2,174	11,561	22,297
Stockholders' Equity 株主資本 (Million ¥)	237,113	235,949	232,329	263,871	307,615	325,648	338,084	332,162	328,660	331,010
Return on Stockholders' Equity 株主資本当期純利益率 (%)	2.6	1.9	2.0	4.6	4.7	4.8	5.5	0.7	3.5	6.7

Notes : Stockholders' Equity is based on the average of the beginning and end of each fiscal year.
Return on Stockholders' Equity = Net Income / Stockholders' Equity

注：株主資本は期中平均
株主資本当期純利益率 = 当期純利益 / 株主資本

Return on Assets 総資産税引前純利益率

Fiscal Year ~年3月期	1992	1993	1994	1995	1996	1997	1998	1999	2000	2001
Income Before Tax 税引前純利益 (Million ¥)	19,803	9,375	13,062	24,948	32,252	39,248	42,243	8,249	21,036	40,037
Total Assets 総資産 (Million ¥)	588,802	599,831	570,991	569,794	600,172	611,930	602,030	586,858	580,038	586,317
Return on Assets 総資産税引前純利益率 (%)	3.4	1.6	2.3	4.4	5.4	6.4	7.0	1.4	3.6	6.8

Notes : Total Assets are based on the average of the beginning and end of each fiscal year.
Return on Assets = Income Before Tax / Total Assets

注：総資産は期中平均
総資産税引前純利益率 = 税引前純利益 / 総資産

Stockholders' Equity / Total Assets

株主資本比率

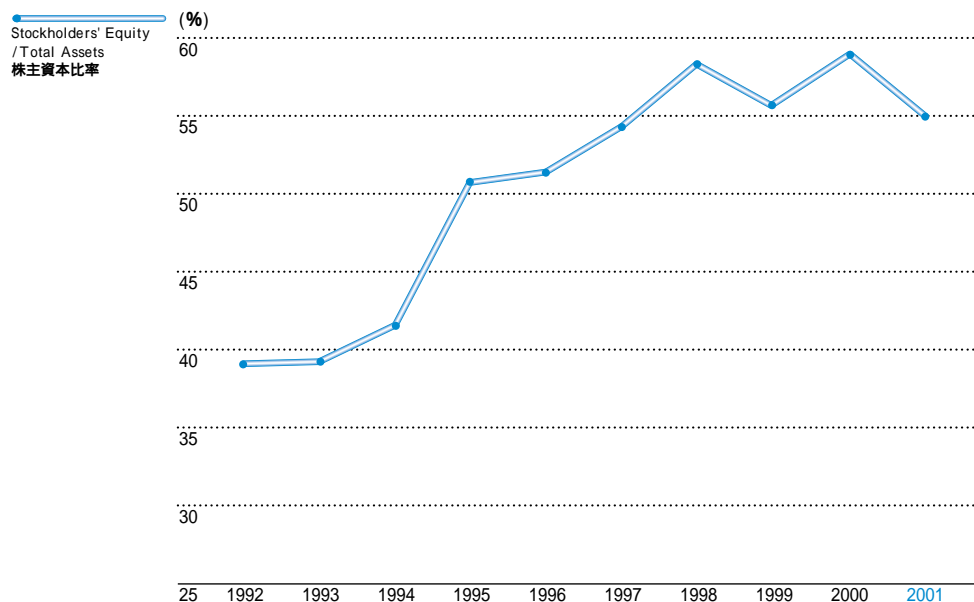

Aggregate market value & Price Book-value Ratio

時価総額・P.B.R.

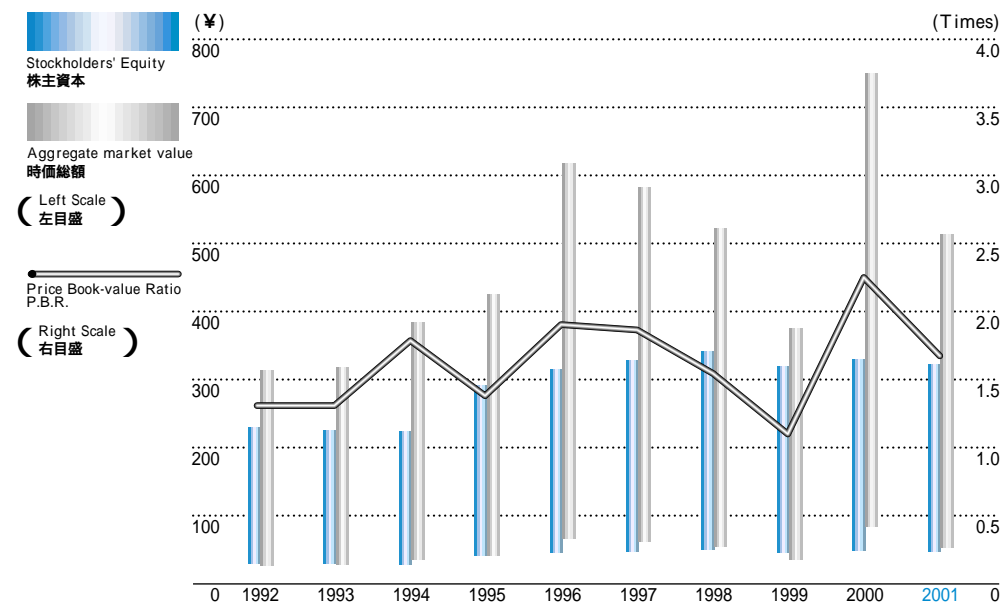

Stockholders' Equity / Total Assets 株主資本比率

Fiscal Year ~年3月期		1992	1993	1994	1995	1996	1997	1998	1999	2000	2001
Debt 負債	(Million ¥)	371,908	355,856	321,468	290,379	290,735	277,828	250,063	259,328	243,427	267,186
Debt / Equity Ratio デットエクイティレシオ	(Times)	1.563	1.521	1.393	0.978	0.926	0.834	0.729	0.807	0.724	0.820
Stockholders' Equity 株主資本	(Million ¥)	237,947	233,951	230,706	297,035	318,194	333,102	343,066	321,258	336,062	325,958
Total Assets 総資産	(Million ¥)	609,855	589,807	552,174	587,414	612,929	610,930	593,129	580,586	579,489	593,144
Stockholders' Equity / Total Assets 株主資本比率	(%)	39.0	39.7	41.8	50.6	51.9	54.5	57.8	55.3	58.0	55.0

Notes : Debt, Stockholders' Equity at the end of each fiscal year. Debt / Equity Ratio = Debt / Stockholders' Equity

注 : 負債・株主資本は各年度末数値 デットエクイティレシオ = 負債 / 株主資本

Aggregate market value Price Book-value Ratio 時価総額・P.B.R.

Fiscal Year ~年3月期		1992	1993	1994	1995	1996	1997	1998	1999	2000	2001
Stockholders' Equity 株主資本	(Million ¥)	237,947	233,951	230,706	297,035	318,194	333,102	343,066	321,258	336,062	325,958
Aggregate market value 時価総額	(¥)	318,735	318,753	390,357	429,846	615,952	576,636	529,457	380,519	750,759	526,866
Number of Shares 株数		230,967,636	230,980,180	230,980,180	262,100,942	262,107,214	262,107,214	262,107,214	257,107,214	257,109,236	249,109,236
Stockholders' Equity per Share 1株当たり株主資本	(¥)	1,030	1,013	999	1,133	1,214	1,271	1,309	1,250	1,307	1,308
Adjusted Stock Price 修正株価	(¥)	1,380	1,380	1,690	1,640	2,350	2,200	2,020	1,480	2,920	2,115
Price Book-value Ratio P.B.R.	(Times)	1.34	1.36	1.69	1.45	1.94	1.73	1.54	1.18	2.23	1.62

Notes : Stockholders' Equity is based on Common Shares.

Number of Shares issued, Stockholders' Equity and Adjusted Stock Price at the end of each fiscal year.

注 : 株主資本は発行済普通株式に基づいています。

発行済株式数、株主資本、修正株価は各年度末数値

Cash Flows per Share

1株当りキャッシュフロー -

Cash Flows per Share
1株当りキャッシュフロー

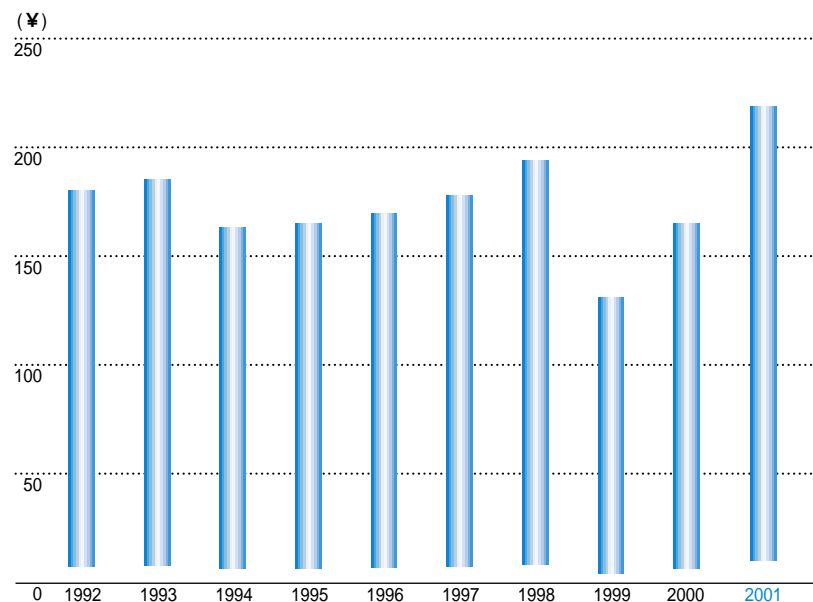

Cash Flows per Share 1株当りキャッシュフロー -

Fiscal Year ~年3月期	1992	1993	1994	1995	1996	1997	1998	1999	2000	2001
Cash Flows キャッシュフロー (Million ¥)	40,908	42,180	38,192	43,590	44,783	46,973	49,833	33,570	43,006	54,514
Number of Shares 株数	230,967,636	230,980,180	230,980,180	262,100,942	262,107,214	262,107,214	262,107,214	257,107,214	257,109,236	249,109,236
Cash Flows per Share 1株当りキャッシュフロー (¥)	177	183	165	166	171	179	190	131	167	219

Notes : Cash Flows per Share are based on Common Shares.
Number of Shares issued at the end of each fiscal year.
Cash Flows = Net Income +(Depreciation & Amortization)

注：1株当りキャッシュフローは、発行済普通株式に基づいています。
発行済株式数は各年度末数値
キャッシュフロー = 当期純利益 + 減価償却費

Consolidated Statements of Income 連結損益計算書

(Million ¥)

Years ended March 31	1992	1993	1994	1995	1996	1997	1998	1999	2000	2001
NET SALES 売上高	483,247	462,702	460,869	489,700	525,289	594,261	611,795	555,820	555,358	594,259
COSTS AND EXPENSES : 売上原価及び費用										
Cost of sales 売上原価	319,589	308,579	312,248	324,666	342,500	388,005	387,445	364,314	358,911	376,149
Selling, general and administrative 販売費及び一般管理費	103,463	102,430	100,193	100,333	109,117	130,163	138,404	136,734	133,662	131,203
Research and development 試験研究開発費	33,587	31,004	28,698	31,223	34,433	35,188	39,914	42,383	36,605	42,513
Interest expense (income), net 支払利息及び受取利息 純額	3,995	5,601	6,428	5,102	2,044	1,591	682	862	750	111
Foreign exchange loss (gain) 為替差損益	(312)	835	1,272	3,657	5,027	860	4,419	2,766	2,841	1,389
Other, net その他費用(収益) 純額	3,122	4,878	(1,032)	(229)	(84)	(794)	(1,312)	(28)	1,553	2,812
Total 合計	463,444	453,237	447,807	464,752	493,037	555,013	569,552	547,031	534,322	554,222
INCOME BEFORE INCOME TAXES, MINORITY INTERESTS AND EXTRAORDINARY ITEM 法人税等・少数株主損益及び特別項目調整前純利益	19,803	9,375	13,062	24,948	32,252	39,248	42,243	8,249	21,036	40,037
INCOME TAXES : 法人税等										
Current 当期税額	13,409	8,918	12,302	13,150	18,107	22,915	24,579	12,426	14,857	22,720
Deferred 繰延税額	(278)	(4,444)	(2,863)	705	(337)	342	(1,305)	(8,591)	(5,809)	(5,402)
Tax effects of subsidiaries' operating loss carryforwards 子会社での繰越欠損金の期間調整税額	333	2,047	*1(617)	(1,497)	(731)	(305)	(176)	(142)	-	-
Adjustment of Deferred Tax Assets and Liabilities for Enacted Changes in Tax Rate 標準税率の変更影響額	-	-	-	-	-	-	273	2,351	-	-
Total 合計	13,464	6,521	8,822	12,358	17,039	22,952	23,371	6,044	9,048	17,318
INCOME BEFORE MINORITY INTERESTS AND EXTRAORDINARY ITEM 少数株主損益及び特別項目調整前純利益	6,339	2,854	4,240	12,590	15,213	16,296	18,872	2,205	11,988	22,719
MINORITY INTERESTS 少数株主損益	500	328	134	438	626	557	168	31	427	422
INCOME BEFORE EXTRAORDINARY ITEM 特別項目調整前純利益	5,839	2,526	4,106	12,152	14,587	15,739	18,704	2,174	11,561	22,297
EXTRAORDINARY ITEM : 特別項目										
Reduction of income taxes arising from utilization of subsidiaries' operating loss carryforwards 子会社での繰越欠損金の利用により生じた法人税等の軽減額	333	2,047	*2 584	-	-	-	-	-	-	-
NET INCOME 当期純利益	6,172	4,573	4,690	12,152	14,587	15,739	18,704	2,174	11,561	22,297
										(¥)
NET INCOME PER SHARE (Basic) 1株当り当期純利益	-	-	20.3	50.8	55.7	60.1	71.4	8.3	45.0	87.4
(Diluted) 潜在株式調整後1株当り当期純利益	26.1	19.6	20.1	49.4	54.5	58.8	69.8	8.3	44.5	85.3
CASH DIVIDENDS PER SHARE APPLICABLE TO PERIOD 現金配当金	13.0	13.0	13.0	13.0	13.0	13.0	13.0	13.0	13.0	13.0

*1 Tax benefits of subsidiaries' operating loss carry forwards due to a change in accounting principle as required by SFAS No.109.

*2 Cumulative effect on prior years due to a change in accounting principle as required by SFAS No. 109.

*1 法人税等の新会計基準(SFAS No.109)適用により発生した子会社での繰越欠損金にかかる税効果額

*2 法人税等の新会計基準(SFAS No.109)適用による期首累積影響額

Consolidated Balance Sheets 連結貸借対照表

(Million ¥)

Years ended March 31	1992	1993	1994	1995	1996	1997	1998	1999	2000	2001
ASSETS 資産の部										
CURRENT ASSETS : 流動資産										
Cash and cash equivalents 現金及び現金同等物	123,592	105,071	92,731	90,056	87,864	79,288	68,365	88,900	88,670	85,621
Short-term investments 短期投資	3,768	11,707	8,663	20,009	24,065	29,035	6,142	1,054	6,300	—
Notes and accounts receivable, trade 受取手形及び売掛金	107,635	102,573	105,295	106,389	124,977	133,771	138,149	134,183	130,355	133,798
Allowance for doubtful receivables 貸倒引当金	(3,302)	(3,360)	(3,883)	(2,782)	(2,853)	(3,023)	(3,301)	(2,450)	(2,001)	(2,194)
Inventories たな卸資産	70,003	61,281	67,268	71,276	80,508	85,966	94,981	79,535	77,807	91,593
Deferred income taxes 繰延税金	5,314	4,470	7,750	9,590	10,707	10,139	11,798	11,336	9,026	12,186
Other current assets その他流動資産	5,759	6,603	4,643	4,022	4,939	8,310	12,613	9,705	7,116	7,875
Total current assets 流動資産合計	312,769	288,345	282,467	298,560	330,207	343,486	328,747	322,263	317,273	328,879
PROPERTY, PLANT AND EQUIPMENT : 有形固定資産										
Land 土地	39,067	43,053	44,647	54,097	53,734	51,169	50,166	50,598	51,082	50,479
Buildings 建物及び構築物	77,737	87,142	97,966	98,486	103,702	107,036	107,974	111,263	110,330	113,414
Machinery and equipment 機械その他	146,499	143,901	138,388	133,984	139,307	143,736	143,809	135,197	129,639	132,945
Construction in progress 建設仮勘定	16,295	14,316	4,941	1,813	2,198	2,746	4,124	4,326	3,933	5,680
Total 小計	279,598	288,412	285,942	288,380	298,941	304,687	306,073	301,384	294,984	302,518
Accumulated depreciation 減価償却累計額	(104,778)	(112,617)	(118,494)	(120,169)	(126,246)	(134,277)	(135,591)	(138,489)	(138,950)	(143,399)
Net property, plant and equipment 有形固定資産合計	174,820	175,795	167,448	168,211	172,695	170,410	170,482	162,895	156,034	159,119
OTHER ASSETS : 投資その他の資産										
Investments in and advances to associates 関連会社に対する投資及び貸付金	1,684	1,888	2,047	1,646	1,924	2,098	1,843	1,770	2,013	853
Investment securities 投資有価証券	86,605	91,078	65,953	86,144	71,170	59,710	55,336	54,114	69,397	57,500
Leasehold deposits 施設借用保証金	12,951	14,152	14,496	12,149	12,116	11,809	11,730	12,035	10,608	11,159
Deferred income taxes 繰延税金	-	-	3,621	3,825	7,410	6,945	7,507	8,834	6,415	17,986
Other その他の資産	21,025	18,549	16,142	16,879	17,407	16,472	17,484	18,675	17,749	17,648
Total other assets 投資その他の資産合計	122,266	125,667	102,259	120,643	110,027	97,034	93,900	95,428	106,182	105,146
TOTAL 資産合計	609,855	589,807	552,174	587,414	612,929	610,930	593,129	580,586	579,489	593,144

Note : " Deferred income taxes " listed under " OTHER ASSETS " in 1994 due to a change in accounting principal as required by SFAS No. 109.

注 : 1994年度の『その他資産』における『繰延税金』は新会計基準(SFAS No.109)の適用による。

Consolidated Balance Sheets 連結貸借対照表

(Million ¥)

Years ended March 31	1992	1993	1994	1995	1996	1997	1998	1999	2000	2001
LIABILITIES AND STOCKHOLDERS' EQUITY 負債・資本の部										
CURRENT LIABILITIES : 流動負債										
Bank loans 短期借入金	21,245	9,100	8,864	6,109	11,564	15,302	12,578	27,946	10,242	8,961
Notes and accounts payable, trade 支払手形・買掛金・未払金	70,461	68,834	68,455	73,062	80,307	95,552	88,756	70,971	78,467	82,225
Accrued expenses 未払費用	21,319	19,162	18,105	19,112	20,865	22,478	23,117	20,924	21,430	24,484
Income taxes 未払税金	6,461	4,364	8,126	9,864	11,472	16,236	15,011	9,020	11,334	14,797
Other current liabilities その他流動負債	16,120	19,176	19,267	25,814	24,203	25,603	29,020	26,625	24,741	26,628
Current portion of long-term debt 一年以内に返済予定の長期債務	3,691	74,354	77,216	24,258	42,202	18,024	8,466	2,167	1,262	26,340
Total current liabilities 流動負債合計	139,297	194,990	200,033	158,219	190,613	193,195	176,948	157,653	147,476	183,390
LONG-TERM DEBT : 長期借入金	210,766	142,828	100,363	97,375	55,349	41,821	33,500	56,610	57,968	31,957
DEFERRED INCOME TAXES : 繰延税金	5,833	646	3,249	11,912	17,195	13,145	11,335	908	3,725	23
TERMINATION AND RETIREMENT BENEFITS : 退職給付引当金	10,206	11,061	11,778	12,222	23,693	22,909	24,913	40,076	30,629	48,929
OTHER LONG-TERM LIABILITIES : その他固定負債	-	-	-	3,759	1,974	108	367	1,525	1,114	370
MINORITY INTERESTS IN SUBSIDIARIES : 少数株主持分	5,806	6,331	6,045	6,892	5,911	6,650	3,000	2,556	2,515	2,517
STOCKHOLDERS' EQUITY : 資本										
Common stock of ¥50 per value 資本金(普通株式 額面50円)	38,680	38,688	38,688	64,075	64,079	64,079	64,079	64,079	64,082	64,082
Additional paid-in capital 資本剰余金	73,620	73,626	73,626	98,696	98,702	98,702	98,702	98,702	98,705	98,705
Legal reserve 利益準備金	3,997	4,362	4,725	5,087	5,473	5,963	6,314	6,811	7,250	7,652
Retained earnings その他剰余金	125,993	127,198	128,522	137,107	147,900	159,741	174,686	166,020	173,804	174,077
Accumulated other comprehensive income その他の包括利益累計額	(4,343)	(9,923)	(14,855)	(7,930)	2,040	4,617	(715)	(14,012)	(7,168)	(17,346)
Cumulative translation adjustments 為替換算調整額	(4,343)	(9,923)	(14,855)	(16,879)	(9,057)	(3,320)	(5,912)	(11,954)	(20,998)	(13,712)
Minimum pension liability adjustments 退職年金負債調整額	-	-	-	-	(4,639)	(2,146)	(1,401)	(7,138)	-	(7,251)
Net unrealized gain on securities 未実現有価証券評価損益	-	-	-	8,949	15,736	10,083	6,598	5,080	13,830	3,617
Transury stock 自己株式	-	-	-	-	-	-	-	(342)	(611)	(1,212)
Total stockholders' equity 資本合計	237,947	233,951	230,706	297,035	318,194	333,102	343,066	321,258	336,062	325,958
TOTAL 負債・資本合計	609,855	589,807	552,174	587,414	612,929	610,930	593,129	580,586	579,489	573,144

Consolidated Statements of Cash Flows 連結資金収支計算書

(Million ¥)

Years ended March 31	1992	1993	1994	1995	1996	1997	1998	1999	2000	2001
OPERATING ACTIVITIES : 営業活動における資金収支										
Net Income 当期純利益	6,172	4,573	4,690	12,152	14,587	15,739	18,704	2,174	11,561	22,297
Adjustments to reconcile net income to net cash provided by operating activities : 営業活動における資金収支と当期純利益の調整										
Depreciation and amortization 減価償却費	34,736	37,607	33,502	31,438	30,196	31,234	31,129	31,396	31,445	32,217
Termination and retirement benefits 退職給付引当金の増減	(700)	834	717	444	(154)	4,574	2,004	4,178	5,778	4,990
Deferred income taxes 繰延税金	(217)	(4,622)	(3,802)	(792)	(1,242)	(62)	(634)	(6,358)	(5,809)	(5,402)
Noncash interest expense, net 資金収支を伴わない支払利息	1,875	1,875	1,514	1,100	-	-	-	-	-	-
Minority interests 少数株主利益	500	328	134	438	626	557	168	31	427	422
Loss on sale of business entities 子会社・事業の売却による損	-	-	-	-	-	-	-	286	-	-
Change in assets and liabilities, net of effects of acquisitions : (会社買収による影響を除く)										
Notes and accounts receivable - trade 受取手形及び売掛金	9,083	5,601	(2,199)	(2,195)	(16,936)	(7,927)	(3,537)	2,025	2,507	(5,593)
Inventories たな卸資産	(5,458)	8,792	(5,987)	(4,008)	(7,289)	(4,163)	(8,412)	10,529	(534)	(13,320)
Other assets その他の資産	(6,151)	(3,735)	2,077	(2,578)	494	(2,080)	(7,004)	5,306	(3,030)	875
Notes and accounts payable - trade 支払手形及び買掛金	(6,221)	(3,931)	(97)	4,626	5,841	12,000	(4,315)	(11,969)	10,062	3,620
Income taxes payable 未払税金	5,989	(2,097)	3,762	1,738	1,455	4,711	(1,998)	(5,967)	2,633	3,438
Accrued expenses and other 未払費用及びその他流動負債	2,939	(300)	(1,058)	3,748	(706)	3,232	4,425	(970)	(585)	4,140
Other - net その他	268	1,647	(3,674)	(688)	(1,155)	(646)	1,556	(1,078)	5,471	3,112
Total adjustments 調整計	24,665	41,999	24,889	33,271	11,130	41,430	13,382	27,409	48,365	28,499
Net cash provided by operating activities 営業活動における資金収支合計	30,837	46,572	29,579	45,423	25,717	57,169	32,086	29,583	59,926	50,796
INVESTING ACTIVITIES : 投資活動における資金収支										
Net proceeds(purchase) of short-term investments and investment securities 短期投資および投資有価証券の増減	(25,019)	(13,261)	2,344	(12,600)	24,757	(2,233)	19,858	4,505	(5,124)	3,985
Capital expenditures 有形固定資産の取得	(57,575)	(34,584)	(26,875)	(30,954)	(34,079)	(29,956)	(35,896)	(36,696)	(31,146)	(37,583)
Acquisition of businesses, net of cash acquired 会社買収および売却	(1,680)	(589)	0	0	0	0	0	1,998	-	-
Increase in leasehold deposits 施設借用保証金の増加	(831)	(851)	(275)	2,338	57	285	5	(527)	1,456	(538)
Proceeds from sales of property, plant and equipment 有形固定資産の売却による収入	963	666	1,411	5,368	3,427	2,818	1,335	1,895	1,081	1,953
Other - net その他	(288)	557	44	0	0	(312)	(2,933)	(186)	(447)	(182)
Net cash used in investing activities 投資活動における資金収支合計	84,430	(48,062)	1,057	(35,848)	(5,838)	(29,398)	(17,631)	(29,011)	(34,180)	(32,365)
Free cash Flow 純現金収支	(53,593)	(1,490)	30,636	9,575	19,879	27,771	14,455	572	25,746	18,431
FINANCING ACTIVITIES : 財務活動における資金収支										
Net borrowings(repayments) of short-term bank loans 短期借入金の増減	(1,250)	(12,455)	(237)	(2,754)	5,141	3,738	(2,864)	15,515	(18,087)	(1,371)
Proceeds from issuance of long-term debt and warrants 長期債務の増加及び新株引受権の発行	57,566	10,822	38,518	22,287	1,050	5,446	648	25,413	775	715
Repayments of long-term debt 長期債務の返済	(8,208)	(9,728)	(76,778)	(77,733)	(26,525)	(43,634)	(18,013)	(8,956)	(3,102)	(1,650)
Proceeds from issuance of common stock pursuant to exercise of warrants 新株引受権の行使による株式の発行	0	0	0	49,918	0	0	0	0	0	0
Dividends paid 支払配当金	(3,002)	(3,003)	(3,003)	(3,003)	(3,355)	(3,407)	(3,408)	(3,372)	(3,371)	(3,337)
Share buyback 消却のための自己株式の取得	-	-	-	-	-	-	-	(6,971)	-	(18,338)
Net cash provided by(used in) financing activities 財務活動における資金収支合計	45,106	(14,364)	(41,500)	(11,285)	(23,689)	(37,857)	(23,637)	21,629	(23,785)	(24,582)
EFFECT OF EXCHANGE RATE CHANGES ON CASH AND CASH EQUIVALENTS 換算レート変動の影響										
NET INCREASE(DECREASE) IN CASH AND CASH EQUIVALENTS 資金収支合計	(9,098)	(18,521)	(12,340)	(2,675)	(2,192)	(8,576)	(10,923)	20,535	(230)	(3,049)
CASH AND CASH EQUIVALENTS AT BEGINNING OF THE YEAR 期首現金及び現金同等物残高	132,690	123,592	105,071	92,731	90,056	87,864	79,288	68,365	88,900	88,670
CASH AND CASH EQUIVALENTS AT END OF THE YEAR 期末現金及び現金同等物残高	123,592	105,071	92,731	90,056	87,864	79,288	68,365	88,900	88,670	85,621

Main Products 主要製品

Industrial Automation Company

Control Equipment(PLCs, Industrial Networking Equipment, Programmable Terminals, Softwares, etc.), Motion Controllers(Inverters, Servo Motors, Servo Drives, etc.), Sensors(Photoelectric Sensors, Proximity Sensors, Displacement Sensors, Safety Light Curtains, Pressure Sensors, Ultrasonic Sensors, Measurement Sensors, etc.), Advanced Sensors(Vision Sensors, Image Sensors, RFID, Laser Markers, 2-Dimensional Code Readers, etc.), Switches(Limit Switches, Basic Switches, Manual Switches, Switches for Consumer Electronics, Relays, Solid-state Relays, I/O Relay Terminals, etc.), Other Control Devices(Timers, Counters, Temperature Controllers, Level Controllers, Protective Devices, Power Supplies, Digital Panel Meters, Transmission Units, Wireless Units, Energy-saving Devices, Safety-related Devices, etc.), Inspection Systems(PCB Inspection Systems, Sheet Inspection Systems, Solder Paste Printing, Other Inspection Systems, etc.).

Electronic Components Company

Switches(Basic Switches, Tactile Switches, Trigger Switches, DIP Switches, etc.), Relays(General-purpose Relays, PCB Relays) Automotive Devices(Keyless Entry Systems, Power Window Switches, Various Automotive Relays, Electric Power Steering Controllers, Detection Switches, Multiplex Controllers, Power Seat Switches, Buckle Switches, Laser Radar Devices, etc.), Amusement Components and Units(Sensors, Keys, IC's, Game Controllers) Connectors, Sensors for Consumer, Micro Lens Alleys, Components for printer and photocopier(Paper Handling Machine, Counterfeit Detectors, etc.).

Social Systems Business Company

Financial Systems(Automated Teller Machines, Cash Dispensers, Automated Bill Changers, POS Systems, Credit / Debit Card Transaction Terminals, Prepaid Card Systems, etc.), Railway Station Systems(Automated Ticket Venders, Automated Passenger Gate, Automated Fare Adjustment Systems, Commuter Ticket Issuing Machine, etc.), Traffic and Road Management Systems(Traffic Management System, Vehicle Information and Communication System, Travel Time Measurement System, Public Transportation Priority System), Parking System, Totalizer System, Security-related System, Millimeter Wave Communication System, Contents-delivery Terminals.

Healthcare Company

Healthcare Equipment(Digital Blood Pressure Monitors, Digital Thermometers, Electronic Pulse Massagers, Chair Massagers, Pedometers, Body-fat Analyzers, Fitness Equipment, etc.), Medical Equipment (Nebulizers, Professional Digital Blood Pressure Monitor, etc.), Health Management Services(Consultations, Health Promotion Programs, etc.).

Others

Creative Service Company: Outsourcing service(consulting with the aim of increasing the efficiency of the client company's indirect operations, and assuming operations such as personnel, accounting, and general affairs on a contract basis) Business Development Group: Personal Computer Peripherals(Terminal Adapters, Modems, Mobile Phone Modems, Uninterrupted Power Supplies, Scanners, Finger print authentication unit), Card Readers, Room Access Control Systems, RF-ID Tags, Photo-sticker Vending Machines, Speech Recognition and Voice Authentication Systems.

インダストリアルオートメーションビジネスカンパニー

コントローラ関連機器(プログラマブルコントローラ、フィールドネットワーク機器、プログラマブルターミナル、各種アプリケーションソフト等)
 モーションコントロール機器(インバータ、サーボモータ、サーボドライバ等)
 センサ(光電センサ、近接センサ、変位センサ、安全センサ、圧力センサ、超音波センサ、計測センサ等)
 アドバンスドセンサ(視覚コンボ、映像コンボ、RFID、レーザーマーカ、2次元コードリーダ等)
 スイッチ(リミットスイッチ、マイクロスイッチ、操作用スイッチ、民生用スイッチ等)
 リレー(ソリッドステートリレー、I/Oリレーターミナル等)
 その他制御用機器(タイマ、カウンタ、電子温度調節器、レベル機器、保護機器、電源、デジタルパネルメータ、伝送機器、無線機器、省エネ機器、安全機器等)
 各種検査装置(基板はんだ検査装置、シート検査装置、ソルダーペースト印刷検査装置等)

エレクトロニクスコンポーネンツビジネスカンパニー

スイッチ(マイクロスイッチ、タクトイルスイッチ、トリガスイッチ、ディップスイッチ等)
 リレー(一般用電磁リレー、プリント基板搭載型リレー等)
 車載電装部品(キーレスエントリーシステム、パワーウィンドウスイッチ、各種車載用リレー、電動パワーステアリングコントローラ、検出スイッチ、多重通信コントローラ、パワーシートスイッチ、バックルスイッチ、レーザーレーダ等)
 アミューズメント機器用部品・ユニット(専用センサ、専用鍵、専用IC、ゲームコントローラ等)
 コネクタ、業務民生用センサ、マイクロレンズアレイ
 複写機、プリンタ向け付属機器(ペーパーハンドリング機器、紙幣鑑別装置等)

ソーシャルシステムズビジネスカンパニー

電子決済システム(現金自動預金支払機、現金自動支払機、紙幣自動両替機、POSシステム、クレジット・デビット決済端末、プリペイドカードシステム等)
 駅務システム(自動券売機、自動改札機、自動精算機、定期券発行機等)
 交通管理・道路管理システム(交通管制システム、道路情報提供システム、旅行時間計測システム、交通流監視支援システム)
 駐車場システム、トータルゼータシステム、警備保障関連機器
 ミリ波無線通信装置、コンテンツデリバリー端末

ヘルスケアビジネスカンパニー

健康機器(電子血圧計、電子体温計、低周波治療器、マッサージャ、歩数計、体脂肪計、フィットネス機器等)
 医用機器(ネプライザ、業務用電子血圧計等)
 健康サービス(健康指導、生活習慣改善プログラム等)

その他

クリエイティブサービスビジネスカンパニー : アウトソーシングサービス(企業における間接業務効率化のためのコンサルティングおよび人事・経理・総務などの業務委託)
 事業開発本部 : パソコン周辺機器(ターミナルアダプタ、モデム、携帯モデム、バックアップ電源、スキャナ、指紋照合ユニット)、カードリーダ、入退出管理システム、RFタグ、プリントシール機、音声自動応答システム

Common Stock Price Range(Osaka Securities Exchange)

株価推移 (大阪証券取引所)

Price Range of Common Stock of OMRON
 株価
 (Left Scale)
 (左目盛)

Adjusted Average for 225 Stocks
 日経平均株価
 (Right Scale)
 (右目盛)

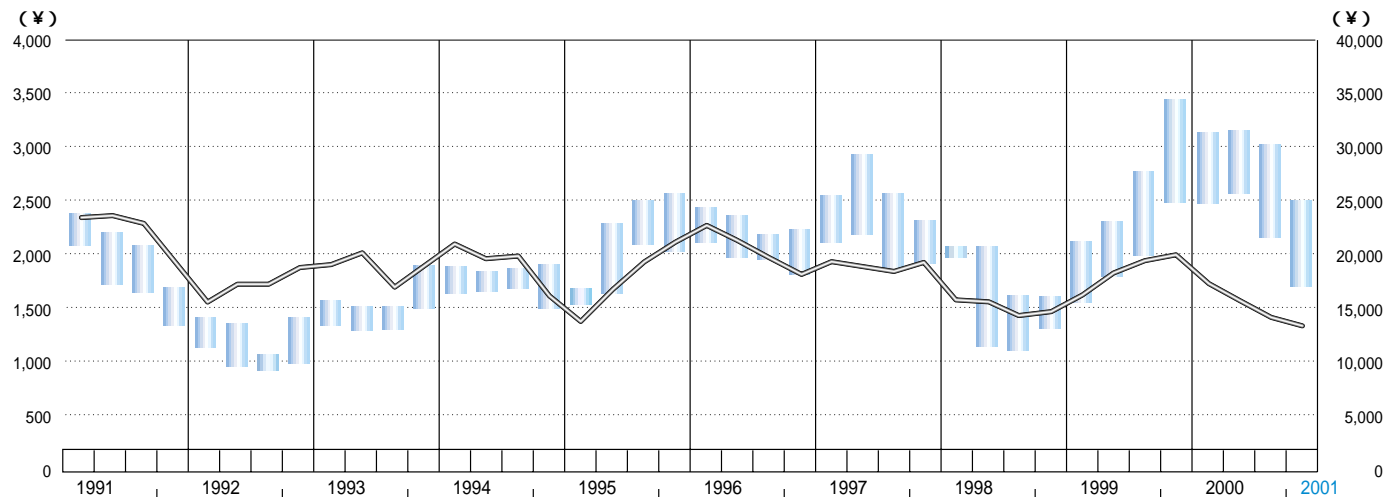

Volume : OMRON
 出来高

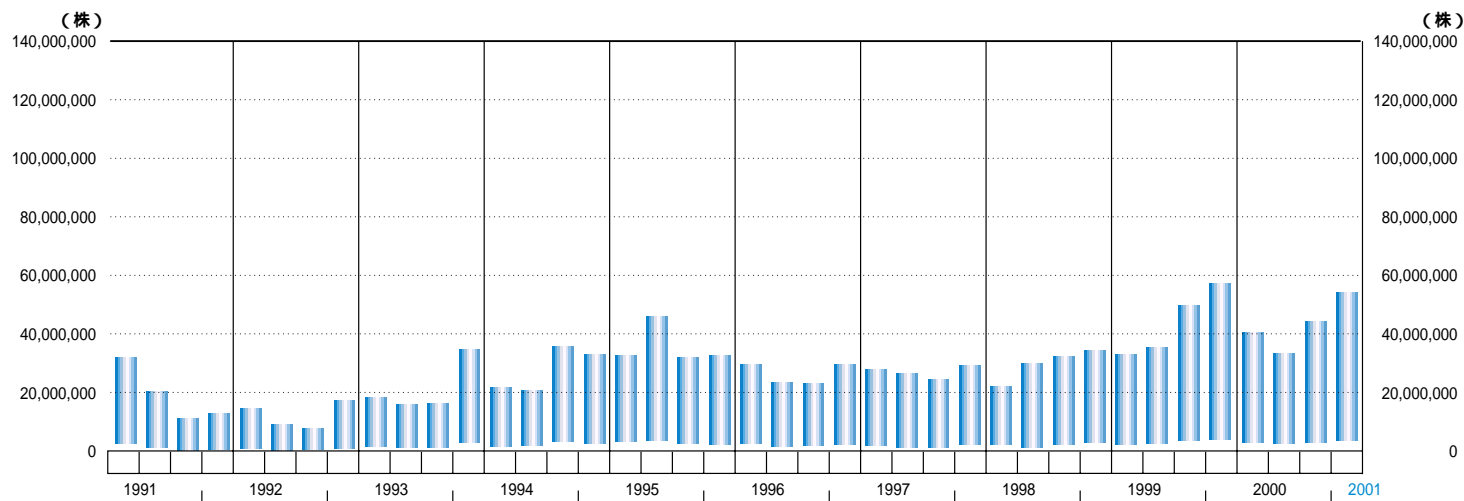

Fiscal Year ~年3月期		1992	1993	1994	1995	1996	1997	1998	1999	2000	2001
Price Range 株価 (¥)	High 高値	2,400	1,430	1,820	1,910	2,710	2,400	2,900	2,230	3,450	3,200
	Low 安値	1,300	938	1,230	1,450	1,500	1,690	1,760	1,059	1,500	1,702

Notes : Prices have been retroactively adjusted for free share distributions.
 Volumes include shares traded at both the Tokyo and Osaka Stock Exchanges.

注 : 株価は株式分割を考慮し、修正したものです。
 出来高は東京証券取引所と大阪証券取引所の合計です。

OMRON Corporate Organization Chart 組織図

Basic Information



From June 21, 2001

概 要

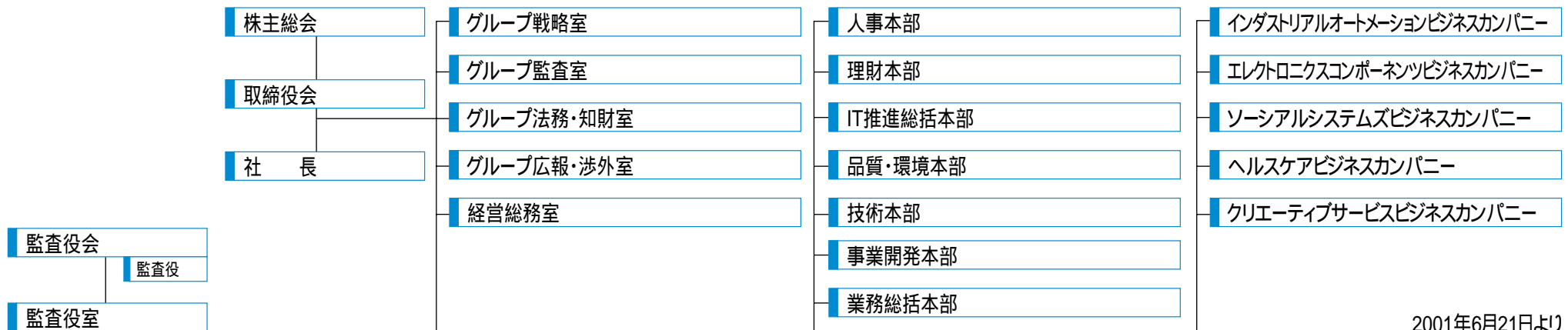

2001年6月21日より

Corporate Data (As of March 31, 2001) 会社概要 (2001年3月31日現在)

Head Office	Shiokoji Horikawa, Simogyo-ku kyoto 600-8530, Japan Phone: (075)344-7000 Fax : (075)344-7001	本社	京都市下京区塩小路通堀川東入 〒600-8530 電話番号 (075)344-7000 FAX番号 (075)344-7001
Tokyo Head Office	3-4-10, Toranomom, Minato-ku Tokyo 105-0001, Japan Phone: (03)3436-7170 Fax : (03)3436-7180 Home Page Address http://www.omron.co.jp (Japanese) http://www.omron.com (English)	東京本社	東京都港区虎ノ門3-4-10 〒105-0001 電話番号 (03)3436-7170 FAX番号 (03)3436-7180 ホームページアドレス http://www.omron.co.jp (日本語) http://www.omron.com (英語)
Date of Establishment	May 10, 1933	創業日	1933年5月10日
Industrial Property Rights	Number of patents: 2,380 (Japan) 1,414 (Overseas) Number of patents pending: 6,293 (Japan) 578 (Overseas)	工業所有権	特許保有権利数 2,380 (日本) 1,414 (海外) 出願中特許数 6,293 (日本) 578 (海外)
Number of Employees	25,067	従業員数	25,067
Paid-in Capital	¥ 64,082 million	払込資本金	640億8千2百万円
Common Stock	Autorized: 495,000,000 shares Issued : 249,109,236 shares Number of shareholders: 25,299	普通株式	授權株式数 495,000,000 株 発行済株式数 249,109,236 株 株主数 25,299
Stock Listings	Osaka Securities Exchange Tokyo Stock Exchange Nagoya Stock Exchange Frankfurt Stock Exchange	上場証券取引所	大阪証券取引所 東京証券取引所 名古屋証券取引所 フランクフルト証券取引所

OMRON Corporation

Shiokoji Horikawa, Shimogyo-ku, kyoto 600-8530, Japan